



## PCR 280

Compact Pirani Capacitance Gauge

# Operating Instructions

## Product Identification

In all communications with Pfeiffer Vacuum, please specify the information given on the product nameplate. For convenient reference copy that information into the space provided below.

Pfeiffer Vacuum, D-35614 Asslar		CE
Typ: .....		
No: .....		 
F-No: .....		
..... V ..... W; LPS		3105467

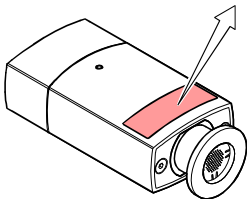

## Validity

This document applies to products with part numbers

PT R26 855	(DN 16 ISO-KF)
PT R26 856	(DN 16 CF-F)

The part number (No) can be taken from the product nameplate. If not indicated otherwise in the legends, the illustrations in this document correspond to gauges with the vacuum connection DN 16 ISO-KF. They apply to gauges with the other vacuum connection by analogy.

We reserve the right to make technical changes without prior notice.

## Intended Use

The Compact Pirani Capacitance Gauge PCR 280 has been designed for vacuum measurement of gases in the pressure range of  $5 \times 10^{-5}$  ... 1500 hPa.

It must not be used for measuring flammable or combustible gases in mixtures containing oxidants (e.g. atmospheric oxygen) within the explosion range.

## Functional Principle

The PCR gauge is a combination gauge consisting of a Pirani sensor and a diaphragm capacitive sensor. Both sensors are constantly active.

At low pressures, only the signal of the Pirani sensor is used for pressure measurement; at high pressures, only the signal of the diaphragm capacitive sensor. To determine the output signal in the intermediate range, both signals are used proportionally to the pressure.

## Patents

EP 0689669 B1, 0689670 B1, 0658755 B1

US Patents 5608168, 4031997, 5583297

## Scope of Delivery

- 1× gauge in clean room packaging
- 1× pin for adjusting settings via buttons
- 1× Operating Instructions English
- 1× Operating Instructions German
- 1× Operating Instructions French

## Contents

Product Identification	2
Validity	2
Intended Use	3
Functional Principle	3
Patents	3
Scope of Delivery	3
<b>1 Safety</b>	<b>5</b>
1.1 Symbols Used	5
1.2 Personnel Qualifications	5
1.3 General Safety Instructions	6
1.4 Liability and Warranty	6
<b>2 Technical Data</b>	<b>7</b>
2.1 Output Signal vs. Pressure	11
2.2 Gas Type Dependence	12
<b>3 Installation</b>	<b>13</b>
3.1 Vacuum Connection	13
3.2 Power Connection	16
<b>4 Operation</b>	<b>18</b>
4.1 Light-emitting diode (LED)	18
4.2 Gas Type Dependence	19
<b>5 Deinstallation</b>	<b>20</b>
<b>6 Maintenance, Repair</b>	<b>22</b>
6.1 Adjusting the Gauge	22
6.2 Troubleshooting	24
<b>7 Returning the Product</b>	<b>24</b>
<b>8 Disposal</b>	<b>25</b>
<b>Conversion Table</b>	<b>26</b>
<b>ETL Certification</b>	<b>26</b>
<b>EC Declaration of Conformity</b>	<b>27</b>

For cross-references within this document, the symbol (→  XY) is used.

# 1 Safety

## 1.1 Symbols Used



**DANGER**

Information on preventing any kind of physical injury.



**WARNING**

Information on preventing extensive equipment and environmental damage.



**Caution**

Information on correct handling or use. Disregard can lead to malfunctions or minor equipment damage.



Notice



Labeling

## 1.2 Personnel Qualifications



**Skilled personnel**

All work described in this document may only be carried out by persons who have suitable technical training and the necessary experience or who have been instructed by the end-user of the product.

### 1.3 General Safety Instructions

- Adhere to the applicable regulations and take the necessary precautions for the process media used.  
Consider possible reactions with the product materials.  
Consider possible reactions (e.g. explosion) of the process media due to the heat generated by the product.
- Adhere to the applicable regulations and take the necessary precautions for all work you are going to do and consider the safety instructions in this document.
- Before beginning to work, find out whether any vacuum components are contaminated. Adhere to the relevant regulations and take the necessary precautions when handling contaminated parts.

Communicate the safety instructions to all other users.

### 1.4 Liability and Warranty

Pfeiffer Vacuum assumes no liability and the warranty becomes null and void if the end-user or third parties

- disregard the information in this document
- use the product in a non-conforming manner
- make any kind of interventions (modifications, alterations etc.) on the product
- use the product with accessories not listed in the product documentation.

The end-user assumes the responsibility in conjunction with the process media used.

Gauge failures due to contamination or wear and tear, as well as expendable parts (e.g. filament) are not covered by the warranty.

## 2 Technical Data

Measurement range	$5 \times 10^{-5} \dots 1500$ hPa
Measurement principle	diaphragm capacitive sensor
10 hPa ... 1500 hPa	
1 ... 10 hPa	crossover range
$5 \times 10^{-5} \dots 1$ hPa	thermal conductance acc. to Pirani
Accuracy (N <sub>2</sub> )	
$5 \times 10^{-4} \dots 1 \times 10^{-3}$ hPa	±50% of reading
$1 \times 10^{-3} \dots 100$ hPa	±15% of reading
100 ... 950 hPa	±5% of reading
950 ... 1050 hPa	±2.5% of reading
Repeatability (N <sub>2</sub> )	
$1 \times 10^{-3} \dots 1100$ hPa	±2% of reading
<hr/>	
Output signal (measurement signal)	
Voltage range	0 ... +8.68 V
Measurement range	+1.2 ... +8.68 V
Error signal	0 V (default)
Voltage vs. pressure	1 V/decade, logarithmic
Output impedance	$2 \times 4.7 \Omega$ , short circuit-proof
Load impedance	>10 k $\Omega$
Response time	<30 ms
<hr/>	
Gauge identification	3.01 k $\Omega$
HV adjustment	at $<10^{-5}$ hPa
ATM adjustment	at >100 hPa
<hr/>	

## Supply



**DANGER**



The gauge may only be connected to power supplies, instruments, or control devices that conform to the requirements of a grounded protective extra-low voltage (SELV) and limited power source (LPS), Class 2. The connection to the gauge has to be fused.

Supply voltage at the gauge	Class 2 / LPS +15 ... +30 VDC
Ripple	$\leq 1 V_{pp}$
Power consumption	$\leq 2.5 W$
Fuse to be connected	1 AT
Electrical connection	Hirschmann GO 6 UM, 6-pin, male
Sensor cable	shielded 0.14 mm <sup>2</sup> /conductor
Cable length	$\leq 100 m$
Grounding concept	→ "Power Connection"
Vacuum connection to signal common	connected via 10 k $\Omega$ , 10 nF
Materials exposed to vacuum	
Vacuum connection	stainless steel 1.4435
Filament	W
Feedthrough	glass
Orifice	stainless steel
Diaphragm	ceramic
Further materials	Ni, NiFe, stainless steel 1.4301, SnAg



Internal volume	
DN 16 ISO-KF	4.7 cm <sup>3</sup>
DN 16 CF-F	8 cm <sup>3</sup>
Permissible pressure (absolute)	≤500 kPa
Bursting pressure (absolute)	1000 kPa
Permissible temperatures	
Operation	+10 °C ... +50 °C
Vacuum connection <sup>1)</sup>	≤80 °C
Filament	<160 °C
Storage	-20 °C ... +65 °C
Relative humidity	
Year's mean	≤65% (no condensation)
During 60 days	≤85% (no condensation)
Mounting orientation	any
Use	indoors only, altitude up to 2000 m NN
Degree of protection	IP 40
Weight	<120 g

<sup>1)</sup> For horizontal mounting orientation only. During bakeout, measurement range, accuracy, and repeatability may deviate from specifications.

### Dimensions [mm]

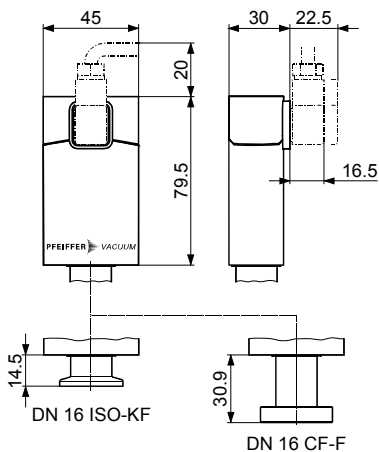

## 2.1 Output Signal vs. Pressure

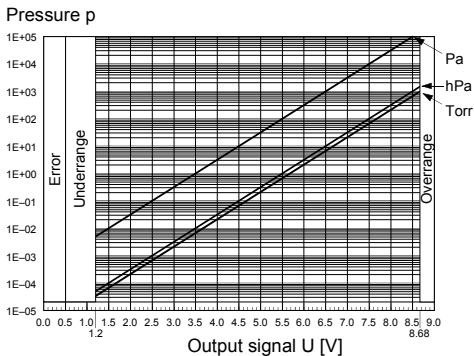

$$p = 10^{(U-c)} \quad \Leftrightarrow \quad U = c + \log_{10} p$$

valid in the range  $5 \times 10^{-5}$  hPa  $\ll$  p  $\ll$  1500 hPa

U	p	c	U	p	c
[V]	[hPa]	5.5	[V]	[micron]	2.625
[V]	[μbar]	2.5	[V]	[Pa]	3.5
[V]	[Torr]	5.625	[V]	[kPa]	6.5
[V]	[mTorr]	2.625			

where p pressure  
 U output signal  
 c constant (pressure unit dependent)

## 2.2 Gas Type Dependence

Indicated pressure (gauge calibrated for air)

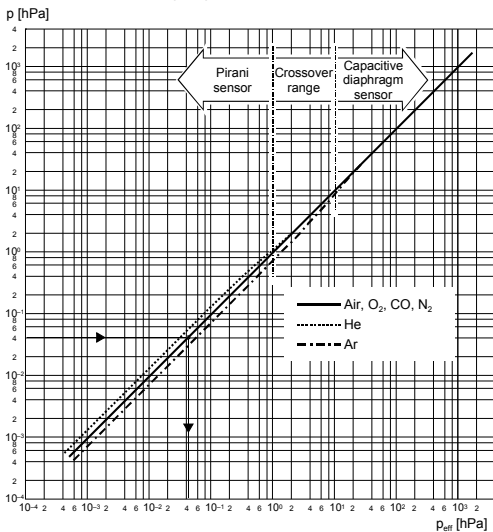

### Calibration factors

valid for Pirani pressure range below 1 hPa

$$p_{\text{eff}} = C \times \text{indicated pressure}$$

Gas type	Calibration factor C	Gas type	Calibration factor C
He	0.8	H <sub>2</sub>	0.5
Ne	1.4	air, O <sub>2</sub> , CO, N <sub>2</sub>	1.0
Ar	1.7	CO <sub>2</sub>	0.9
Kr	2.4	water vapor	0.5
Xe	3.0	Freon 12	0.7

## 3 Installation



### WARNING



WARNING: fragile components

The ceramic sensor may be damaged by impacts.

Do not drop the product and prevent shocks and impacts.

### 3.1 Vacuum Connection



### DANGER



DANGER: overpressure in the vacuum system  
>100 kPa

Injury caused by released parts and harm caused by escaping process gases can result if clamps are opened while the vacuum system is pressurized.

Do not open any clamps while the vacuum system is pressurized. Use the type clamps which are suited to overpressure.



### DANGER



DANGER: overpressure in the vacuum system  
>250 kPa

KF flange connections with elastomer seals (e.g. O-rings) cannot withstand such pressures. Process media can thus leak and possibly damage your health.

Use O-rings provided with an outer centering ring.

**DANGER**

**DANGER:** protective ground

Products that are not correctly connected to ground can be extremely hazardous in the event of a fault.

Electrically connect the gauge to the grounded vacuum chamber. This connection must conform to the requirements of a protective connection according to EN 61010:

- CF flanges fulfill this requirement.
- For gauges with a KF flange, use a conductive metallic clamping ring.

**Caution**

**Caution:** vacuum component

Dirt and damages impair the function of the vacuum component.

When handling vacuum components, take appropriate measures to ensure cleanliness and prevent damages.

**Caution**

**Caution:** dirt sensitive area

Touching the product or parts thereof with bare hands increases the desorption rate.

Always wear clean, lint-free gloves and use clean tools when working in this area.



Mount the gauge so that no vibrations occur. The gauge may be mounted in any orientation. To keep condensates and particles from getting into the measuring chamber preferably choose a horizontal to upright position and consider using a seal with centering ring and filter. If adjustment should be possible after the gauge has been installed, be sure to install it so that the buttons can be accessed with a pin.

Remove the protective lid and connect the product to the vacuum system.

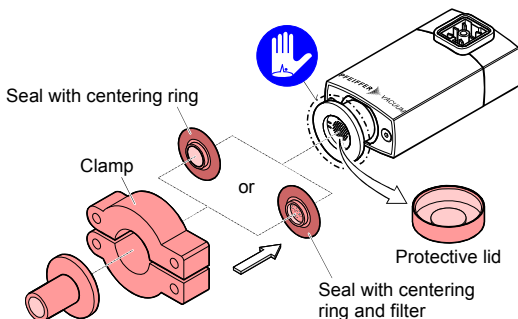

Keep the protective lid.

## 3.2 Power Connection



Make sure the vacuum connection is properly made (→  13).



### DANGER

The gauge may only be connected to power supplies, instruments or control devices that conform to the requirements of a grounded protective extra-low voltage (SELV) and limited power source (LPS), Class 2. The connection to the gauge has to be fused.



Ground loops, differences of potential, or EMC problems may affect the measurement signal. For optimum signal quality, please do observe the following notes:

- Connect the cable shield to ground on one side via the connector housing. Do not connect the other side of the shield.
- Connect the supply common with protective ground directly at the power supply.
- Use differential measurement input (signal common and supply common conducted separately).
- Potential difference between supply common and housing  $\leq 18$  V (overvoltage protection).



If no sensor cable is available, make one according to the following diagram. Connect the sensor cable.

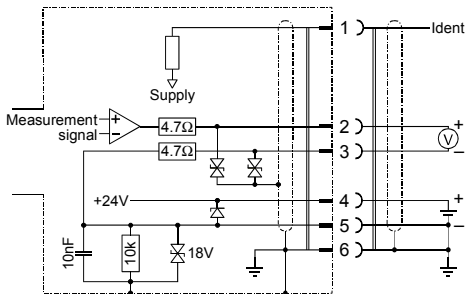

#### Electrical connection

- Pin 1 Gauge identification
- Pin 2 Measurement signal
- Pin 3 Signal common
- Pin 4 Supply
- Pin 5 Supply common (GND)
- Pin 6 Screen

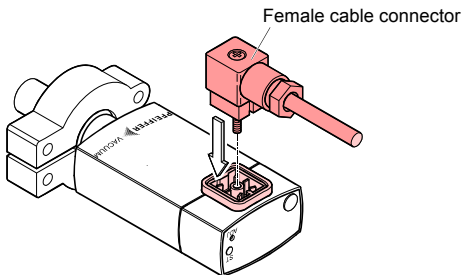
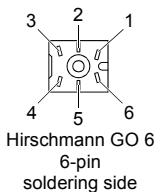

## 4 Operation

When the supply voltage is applied, the measurement signal is available at the connector (→ "Power Connection").

Allow a stabilization period of at least 10 minutes. It is advisable to operate the gauge continuously, irrespective of the pressure.

The gauge is factory calibrated. Due to long time operation or contamination, a zero drift could occur. Periodically check the zero and adjust it if necessary (adjusting the gauge → 22).

### 4.1 Light-emitting diode (LED)

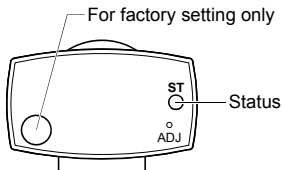

LED	State	Meaning
<ST>	off	no supply voltage
	lit green	measurement mode
	lit red	error

## 4.2 Gas Type Dependence

Pressure range	Measurement principle	Gas type dependence
10 ... 1500 hPa	diaphragm capacitive sensor	independent of gas type, no correction required
1 ... 10 hPa	diaphragm capacitive sensor and Pirani sensor	crossover range
$5 \times 10^{-5}$ ... 1 hPa	Pirani sensor	proportional to pressure <sup>2)</sup>

---

<sup>2)</sup> The pressure reading applies to dry air, O<sub>2</sub>, CO and N<sub>2</sub>. For other gases, it has to be converted (calibration factors (→  12)).

## 5 Deinstallation



### WARNING



WARNING: fragile components

The ceramic sensor may be damaged by impacts.

Do not drop the product and prevent shocks and impacts.



### DANGER



DANGER: contaminated parts

Contaminated parts can be detrimental to health and environment.

Before beginning to work, find out whether any parts are contaminated. Adhere to the relevant regulations and take the necessary precautions when handling contaminated parts.



### Caution



Caution: vacuum component

Dirt and damages impair the function of the vacuum component.

When handling vacuum components, take appropriate measures to ensure cleanliness and prevent damages.

**Caution**

Caution: dirt sensitive area

Touching the product or parts thereof with bare hands increases the desorption rate.

Always wear clean, lint-free gloves and use clean tools when working in this area.

- 1** Vent the vacuum system.
- 2** Put the gauge out of operation.
- 3** Untighten the fastening screw and disconnect the sensor cable.
- 4** Remove gauge from the vacuum system and install the protective lid.

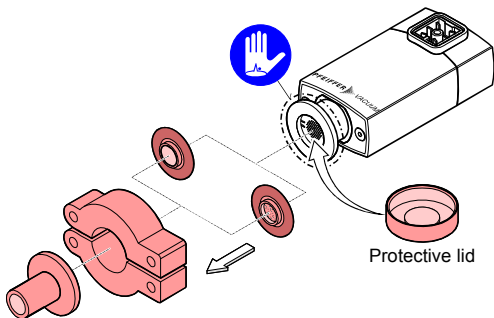

## 6 Maintenance, Repair



Gauge failures due to contamination and wear and tear, as well as expendable parts (e.g. filament), are not covered by the warranty.

Pfeiffer Vacuum assumes no liability and the warranty becomes null and void if any repair work is carried out by the end-user or third parties.

### 6.1 Adjusting the Gauge

The gauge is factory calibrated. Due to long time operation or contamination, a zero drift could occur. Periodically check the zero and adjust it if necessary.

For adjusting the zero, operate the gauge under the same constant ambient conditions and in the same mounting orientation as normally.

The gauge is adjusted to default values. However, it can also be adjusted to other pressure values, if the exact pressure value is known (reference measurement).

- 1** If you are using a seal with centering ring and filter, check that they are clean or replace them if necessary (→ "Deinstallation").
- 2** Put the gauge into operation and operate it at atmospheric pressure for at least 10 minutes.

- 3 Briefly press the <ADJ> button with a pin (max.  $\varnothing 1.1$  mm) and the ATM adjustment is carried out: The Pirani sensor is adjusted to 1000 hPa by default.

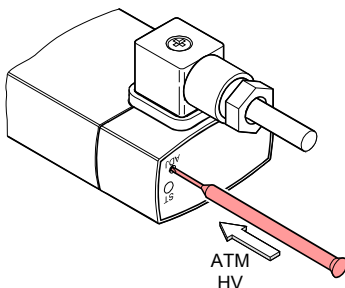

- 4 Evacuate the vacuum system to  $p \ll 10^{-5}$  hPa and wait at least 2 minutes.
  - 5 Press the <ADJ> button with a pin and the HV adjustment is carried out: The gauge is adjusted to  $5 \times 10^{-5}$  hPa (default).
- ✓ If the pressure value  $4.99 \times 10^{-5}$  hPa is output at the measurement value output or on the LCD display, the adjustment has been successful. Otherwise, repeat the adjustment procedure.

## 6.2 Troubleshooting



In case of an error, it may be helpful to just turn off the mains supply and turn it on again after 5 s.

Problem	Possible cause	Correction
Output signal permanently =0V	Sensor cable defective or not correctly connected	Check the sensor cable
	No supply voltage	Turn on the power supply
	Error	Remedy the error
	Gauge in an undefined status	Turn the gauge off and on again after 5 s (reset)

## 7 Returning the Product



### WARNING



**WARNING:** forwarding contaminated products  
Contaminated products (e.g. radioactive, toxic, caustic or microbiological hazard) can be detrimental to health and environment.  
Products returned to Pfeiffer Vacuum should preferably be free of harmful substances. Adhere to the forwarding regulations of all involved countries and forwarding companies and enclose a duly completed declaration of contamination<sup>1)</sup>.

<sup>1)</sup> Form under [www.pfeiffer-vacuum.com](http://www.pfeiffer-vacuum.com)

Products that are not clearly declared as "free of harmful substances" are decontaminated at the expense of the customer. Products not accompanied by a duly completed declaration of contamination are returned to the sender at his own expense.



## 8 Disposal



### DANGER



**DANGER:** contaminated parts

Contaminated parts can be detrimental to health and environment.

Before beginning to work, find out whether any parts are contaminated. Adhere to the relevant regulations and take the necessary precautions when handling contaminated parts.



### WARNING



**WARNING:** substances detrimental to the environment

Products or parts thereof (mechanical and electric components, operating fluids etc.) can be detrimental to the environment.

Dispose of such substances in accordance with the relevant local regulations.

### Separating the components

After disassembling the product, separate its components according to the following criteria:

- Contaminated components  
Contaminated components (radioactive, toxic, caustic or biological hazard etc.) must be decontaminated in accordance with the relevant national regulations, separated according to their materials, and disposed of.
- Other components  
Such components must be separated according to their materials and recycled.

## Conversion Table

	mbar	bar	Pa	hPa	kPa	Torr mm HG
mbar	1	$1 \times 10^{-3}$	100	1	0.1	0.75
bar	$1 \times 10^3$	1	$1 \times 10^5$	$1 \times 10^3$	100	750
Pa	0.01	$1 \times 10^{-5}$	1	0.01	$1 \times 10^{-3}$	$7.5 \times 10^{-3}$
hPa	1	$1 \times 10^{-3}$	100	1	0.1	0.75
kPa	10	0.01	$1 \times 10^3$	10	1	7.5
Torr mm HG	1.332	$1.332 \times 10^{-3}$	133.32	1.3332	0.1332	1

$$1 \text{ Pa} = 1 \text{ N/m}^2$$

## ETL Certification



### ETL LISTED

The product PCR 280 complies with the requirements of the following

Standards:

UL 61010-1, Issued: 2004/07/12 Ed: 2

Rev: 2008/10/28

CAN/CSA C22.2#61010-1,

Issued: 2004/07/12 Ed:2 (R2009)

## EC Declaration of Conformity



We, Pfeiffer Vacuum, hereby declare that the equipment mentioned below complies with the provisions of the Directive relating to electromagnetic compatibility 2004/108/EC and the Directive on the restriction of the use of certain hazardous substances in electrical and electronic equipment 2011/65/EU.

### Compact Pirani Capacitance Gauge

PCR 280

#### Standards

Harmonized and international / national standards and specifications:

- EN 61000-6-2:2005 (EMC: generic immunity standard)
- EN 61000-6-3:2007 (EMC: generic emission standard)
- EN 61010-1:2010 (Safety requirements for electrical equipment for measurement, control and laboratory use)
- EN 61326-1:2006 (EMC requirements for electrical equipment for measurement, control and laboratory use)

#### Manufacturer / Signatures

Pfeiffer Vacuum GmbH, Berliner Straße 43, D-35614 Asslar

9 December 2013

9 December 2013

Manfred Bender  
Managing director

Dr. Matthias Wiemer  
Managing director

**Vacuum solutions  
from a single source**

Pfeiffer Vacuum stands for innovative and custom vacuum solutions worldwide, technological perfection, competent advice and reliable service.

**Complete range  
of products**

From a single component to complex systems: We are the only supplier of vacuum technology that provides a complete product portfolio.

**Competence in  
theory and practice**

Benefit from our know-how and our portfolio of training opportunities! We can support you with your plant layout and provide first-class on-site-service worldwide.

**You are looking for a  
perfect vacuum solution?  
Please contact us:**

**Pfeiffer Vacuum GmbH**  
Headquarters • Germany  
Tel.: +49 6441 802-0  
info@pfeiffer-vacuum.de  
[www.pfeiffer-vacuum.com](http://www.pfeiffer-vacuum.com)

